

UNIVERSAL CENTRAL INVERTER

MPS - POWER INVERTER 20-55W, Universal Load Profile

Series MPS
REV #: MPS.02.26.03

OVERVIEW

Mini electrical inverter systems for powering 20 to 55 watts of incandescent, fluorescent, induction or LED lighting loads. Pulse width modulated (PWM) output design provides clean, 60 Hz sinusoidal emergency power to fixtures up to 1000 feet away.

PROJECT: _____

TYPE: _____

CATALOG #: _____

STANDARD



OPTIONAL



- Heavy-duty steel cabinet is finished in white baked-on powder coat paint, providing scratch and corrosion resistance
- Optional special color paint (-SP) finishes are available upon request
- Models are available for surface, recessed, or t-grid mounting

FEATURES

- For powering incandescent, fluorescent, induction and LED fixtures*
- True sinusoidal output for maximum compatibility
- Universal 120/277VAC, 60Hz. Input/ Output
- Unit capacities up to 1150 watts
- Soft-start design reduces fixture in-rush current
- Unit may be installed up to 1,000 feet from controlled fixture(s)
- Lumen output from fixture is 100% of nominal
- Unique design eliminates compatibility problems with LED drivers as well as fluorescent and induction ballasts
- Compatible with dimming ballasts
- Normally-ON and/or Normally-OFF load output
- Provisions for local switching capability - Always on during emergency conditions regardless of local switch position
- Emergency fixtures can be ON, OFF or SWITCHED
- Solid-state, line latched low voltage disconnect provides protection against battery deep discharge
- Long life, maintenance-free lead-calcium battery
- Momentary test switch
- AC-ON, Charge-ON and Inverter-ON LED indicators

* Consult factory for compatibility for other lamp types



ELECTRICAL SPECIFICATIONS

Input

- Input Voltages: 120 or 277VAC ±10%
- Input Frequencies: 60Hz ±2%
- Input Protection: Provided by service panel, 20A max

Output

- Output Voltages: 120 or 277VAC, 60Hz
- Efficiency: 98% at full rated load (line)
- Waveform: Digitally controlled sinusoidal
- Static Voltage: ±5% during battery discharge. 0-100% linear load
- Output Frequencies: 60Hz. ±0.3Hz during emergency cycle
- Output Distortion: Less than 3% THO (linear load)
- Transfer Time: Less than 1.0 second
- Load Power Factor Range: 0.44 Lead to 0.44 Lag
- Minimum Loading: 0% of rated system capacity
- Output Protection: Inverter fuses

ORDERING INFORMATION EXAMPLE: MPS20-S-RTS-SDT

MODEL SERIES	WATTS	OPTIONS ^{1, 2}	
MPS	20	S	Surface mount
	32	R	Recessed mount
	35	T	Plenum-rated T-grid mount
	55	SP	Special housing color (specify)
		RTS	Remote test panel switch
		SDT	Self-testing/diagnostics
		CEC	Title 20 compliant ³

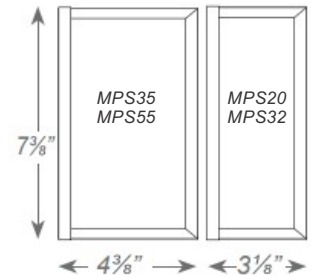
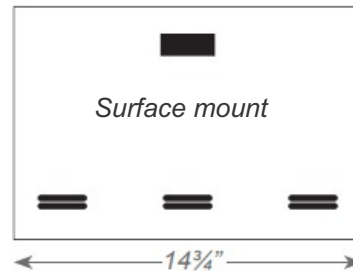

¹ Other options available. Consult factory.
² Some options may impact product UL listing. Consult factory.
³ Only available with 32W and 55W models

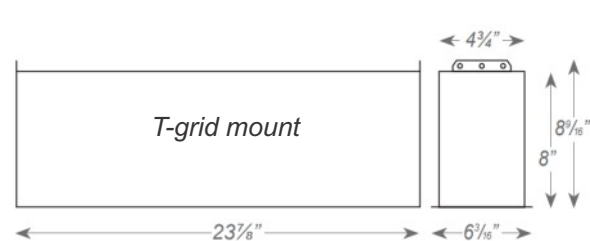
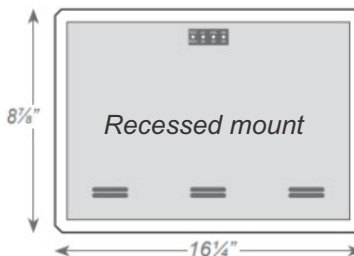

UNIVERSAL CENTRAL INVERTER

Series MPS
REV #: MPS.02.26.03

GENERAL SPECIFICATIONS

	INPUT/OUTPUT VOLTAGE	90 MIN CAPACITY WATTS/VA	TOTAL WEIGHT		EFFICIENCY (FULL LOAD)	BATTERY TYPE	TEMP RANGE (°C)	POWER CONSUMPTION	BATT VOLTS (VDC)	BATT CURRENT	AC INPUT CURRENT (MAX)		THERMAL OUTPUT (BTU)	
			LBS.	KG							120V	277V	ONLINE	EMERGENCY
MPS20	120/277 VAC	20/20	11	5	98%	NiCad	0-50	9W	12	2.1	0.25	0.11	31	22
MPS32	120/277 VAC	32/32	14	6.4	98%	Lead-Calc	20-30	9W	12	3.4	0.34	0.15	7	32
MPS35	120/277 VAC	35/35	12	5.4	98%	NiCad	0-50	9W	12	3.8	0.37	0.16	31	35
MPS55	120/277 VAC	55/55	18	8.2	98%	Lead-Calc	20-30	9W	12	5.7	0.54	0.23	7	47

WARRANTY & LISTINGS

- Unit: (excluding lamps) Full coverage against defects in materials and workmanship for 3 years from date of shipment
- Battery: 3 years full warranty, plus an additional 7 years of pro-rata coverage
- All models are UL924 Listed and meet NFPA 101 Life Safety Code, NEC, OSHA, Local and State Codes. Optional T-Grid models are plenum rated, to UL2043 and meets city of Chicago CCEA Requirements.
- UL Listed for damp locations (0°– 50°C for NiCad models and 20°– 30°C for lead-calcium models).
- Optional -CEC models are Certified to CEC Under Title 20 regulations
- FCC Part 15 Class B Compliant.

BATTERIES & CHARGER

BATTERIES

- **Battery:** Sealed Lead Calcium (10 year life) or Sealed Nickel Cadmium (15 year life)
- **Battery Voltages:** 12VDC for all MPS models
- **Runtime:** 90-minutes standard - based on battery performance at 25°C. Consult factory for other runtime options
- **Battery Protection:** Standard low-voltage disconnect protects the battery from damage during prolonged power failures. Reverse polarity, DC overload, and short circuit protection via DC input fuse.

CHARGER

- **Charger Type:** Fully automatic, temperature compensated, dual-mode charger
- **Power Consumption (charger only):** 9W max for all models
- **Recharge duty cycle:** Meets UL924 standard
- **Controls:** Momentary test switch, AC-ON, Charge-ON and Inverter-ON LEDs
- **Safety:** AC lockout prevents battery discharge prior to initial power up. Brownout protection automatically activates emergency mode upon utility voltage reduction

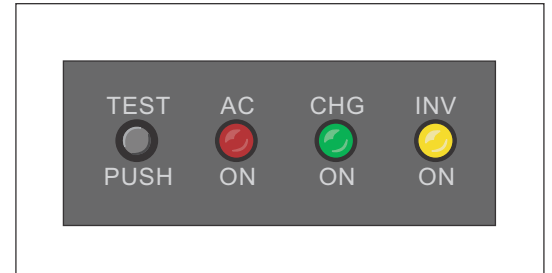

All MPS systems provide a monitoring panel on the front of the unit to show operating status. This panel provides a test switch for user initiated system tests, and a three-LED array that provides an intuitive visual indication of unit readiness.

ENVIRONMENTAL

- **Altitude:** <10,000ft (3,000m) above sea level without derating
- **Operating Temp:** 20°C to 30°C (Lead-Calc); 0°C to 50°C (NiCad)
(Note: Optimal range is 20-30°C. Temperatures outside this range will affect battery performance and life)
- **Relative Humidity:** 95% non-condensing

MPS ADVANTAGE

Compared to traditional, discrete emergency lighting units, the MPS Series provides emergency illumination from a single power source - resulting in less maintenance overhead and routine testing expenses. MPS units lower installation costs by powering existing light fixtures during an emergency. Connected fixtures are powered at full brilliancy for maximum egress lighting and occupant safety.

STANDARD WIRING DIAGRAMS

NORMALLY ON

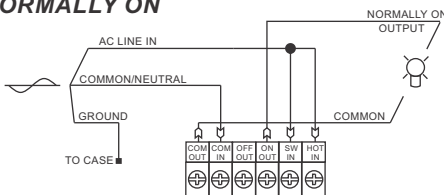

NORMALLY OFF

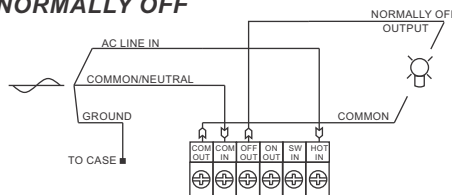

NORMALLY ON & OFF

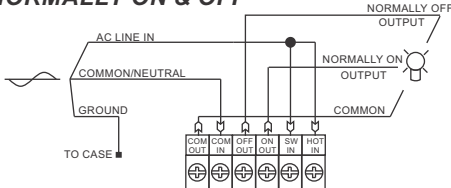

SWITCHED LOADS

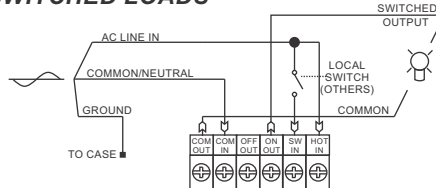

AC INPUT SELECTION

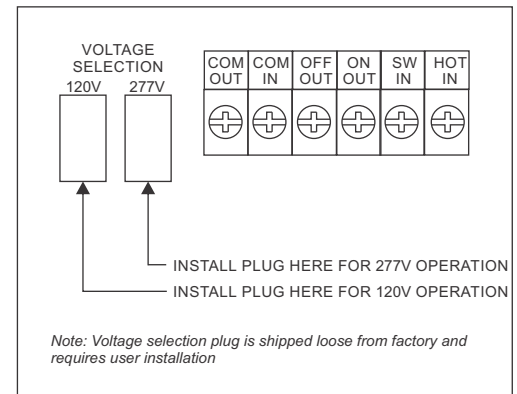

UNIVERSAL CENTRAL INVERTER

Series MPS
REV #: MPS.02.26.03

OPTIONAL ACCESSORIES

SELF TESTING & SELF DIAGNOSTICS OPTION -SDT

FUNCTIONS

The self-diagnostic function is factory preset and performs the following:

- Monitoring of battery, battery charger and connected loads.
- Self-testing and a 30-second battery discharge once every 30 days after normal utility power has been supplied for a minimum of 48 hours.
- Self-testing and a 30-minute battery discharge once every 180 days after normal utility power has been supplied for a minimum of 48 hours.
- Self-testing and a 90-minute battery discharge once every 365 days after normal utility power has been supplied for a minimum of 48 hours.

SERVICE INDICATION

LED INDICATOR	STATUS
Steady GREEN	Normal Service
Blinking RED/GREEN	High Charge Mode
Blinking GREEN	Test Mode
One RED blink	Battery Charger Fault
Two RED blinks	Battery Fault
Four RED blinks	Load Fault

MANUAL TESTING

ACTION	FUNCTION
Push test switch once	30 second Test – One GREEN blink
Double push test switch	30-minute Test – Two GREEN blinks
Triple push test switch	90-minute Test – Three GREEN blinks
Push and hold for 3 sec.	Cancel Test
Push and hold for 6 sec.	System Reset

REMOTE TEST PANEL SWITCH OPTION -RTS

- Remote test switch can be mounted to any standard switch box.
- Suitable for wall or ceiling mount
- Injection-molded, V-0 flame retardant mounting plate in white finish.

- Meets UL924, NFPA 101 Life Safety Code, NEC, OSHA, Local and State Codes.
- Five year warranty

